

### Features

- 80186, 80 MHz CPU
- C Language Based and MiniOS7 Inside
- Compact and Rugged PAC
- 64-bit Hardware Serial Number
- 4/8 Slots for High Profile I/O Modules
- Dual 10/100M Ethernet Ports
- 4 Serial Ports (RS-232/485)
- Operating Temperature: -25 ~ +75°C



### Introduction

The iPAC-8000 is the compact size PAC(Programmable Automation Controller). It supports a variety of connectivity options including Dual 10/100 Base-TX Ethernet ports, one RS-232/485 port, one RS-485 port and two RS-232 ports , and 4/8 slots for high performance Parallel I/O modules (high profile I-8K series) and Serial I/O modules (high profile I-87K series), etc.

The iPAC-8000 is designed for industrial monitoring, measurement and controlling. It has redundant power inputs with 1 kV isolation from noise and surges, and a wide range of operating temperature (-25 ~ +75°C). It can work in the harsh and rough environment.

### Applications

#### Rich I/O Expansion Ability

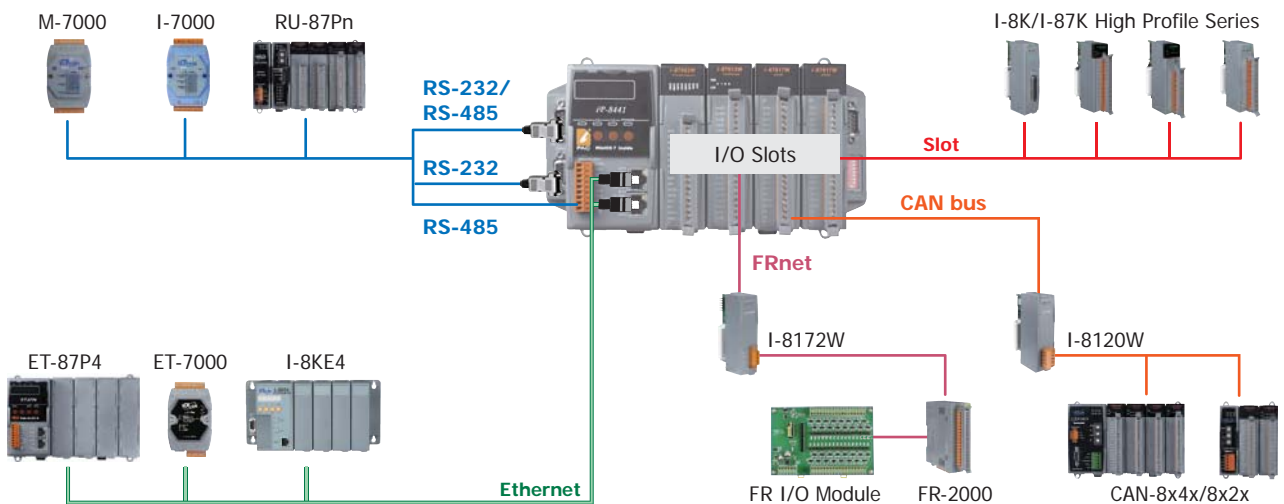

## Specifications

Models	iP-8411	iP-8811	iP-8441	iP-8841	iP-8441-FD	iP-8841-FD
<b>System Software</b>						
OS	MiniOS7 (DOS-like embedded operating system)					
Program Download Interface	RS-232 (COM1) or Ethernet					
Programming Language	C language					
Compilers to create.exe Files	TC++ 1.01 TC 2.01 BC++3.1 ~ 5.2x MSC 6.0 MSVC++ (before version 1.5.2)					
<b>CPU Module</b>						
CPU	80186, 80 MHz					
SRAM	512 KB	768 KB				
Dual Battery Backup SRAM	512 KB; data valid up to 5 years					
Flash	512 KB; with Write Protect Switch					
Expansion Flash Memory	microSD socket (can support microSDHC up to 32 GB)					
NAND Flash Disk	-				256 MB	
EEPROM	16 KB					
NVRAM	31 bytes (battery backup, data valid up to 5 years)					
RTC (Real Time Clock)	Provide second, minute, hour, date, day of week, month, year					
64-bit Hardware Serial Number	Yes, for Software Copy Protection					
Watchdog Timers	Yes (0.8 second)					
DIP Switch	Yes (8 bits)					
<b>Communication Ports</b>						
Ethernet	-	RJ-45 x 2, 10/100 Base-TX (Auto negotiating, Auto MDI/MDI-X, LED indicators)				
COM 0	Internal communication with the high profile I-87K series modules in slots					
COM 1	RS-232 (to update firmware) (Rx/D, Tx/D and GND); non-isolated					
COM 2	RS-485 (Data+, Data-) with internal self-tuner ASIC; 3000 Vdc isolated					
COM 3	RS-232/RS-485 (Rx/D, Tx/D, CTS, RTS and GND for RS-232, Data+ and Data- for RS-485); non-isolated					
COM 4	RS-232 (Rx/D, Tx/D, CTS, RTS, DSR, DTR, CD, RI and GND); non-isolated					
<b>SMMI</b>						
LED Display	Yes, 5-Digit					
Programmable LED Indicators	3					
Push Buttons	4					
Buzzer	-	Yes				
<b>I/O Expansion Slots</b>						
Slot Number	4	8	4	8	4	8
	Note: For High Profile I-8K and I-87K Modules Only					
<b>Mechanical</b>						
Dimensions (W x L x H)	231 x 132 x 111 mm	355 x 132 x 111 mm	231 x 132 x 111 mm	355 x 132 x 111 mm	231 x 132 x 111 mm	355 x 132 x 111 mm
Installation	DIN-Rail or Wall Mounting					
<b>Environmental</b>						
Operating Temperature	-25 ~ +75°C					
Storage Temperature	-30 ~ +80°C					
Ambient Relative Humidity	10 ~ 90% RH (non-condensing)					
<b>Power</b>						
Input Range	+10 ~ +30 Vdc					
Isolation	1 kV					
Redundant Power Inputs	Yes, with one power relay (1 A @ 24 Vdc) for alarm					
Capacity	30 W	30 W	30 W	30 W	30 W	30 W
Consumption	6.7 W	7.2 W	6.7 W	7.2 W	6.7 W	7.2 W

## Appearance

**iP-8811**

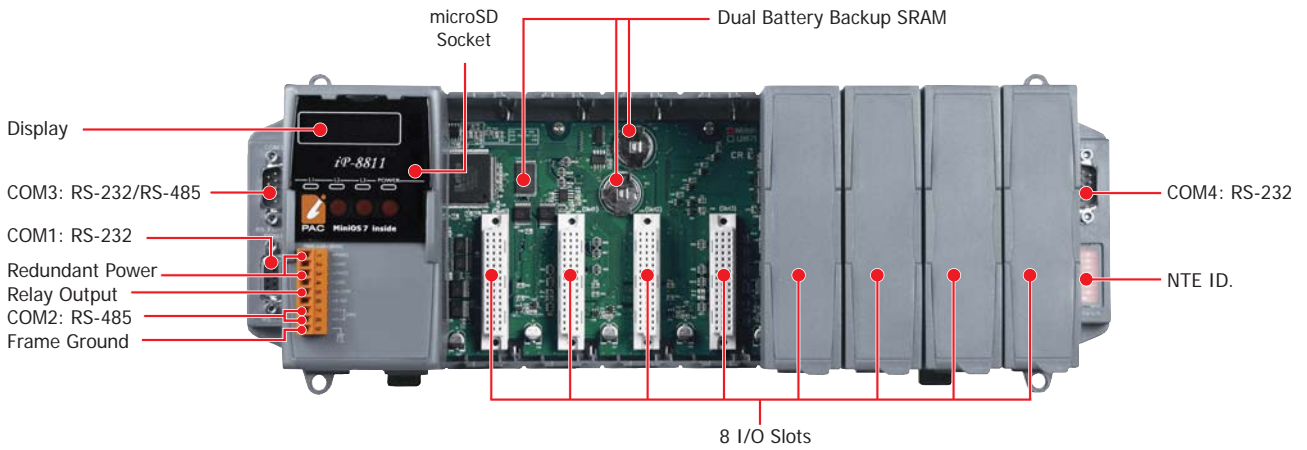

**iP-8841/iP-8841-FD**

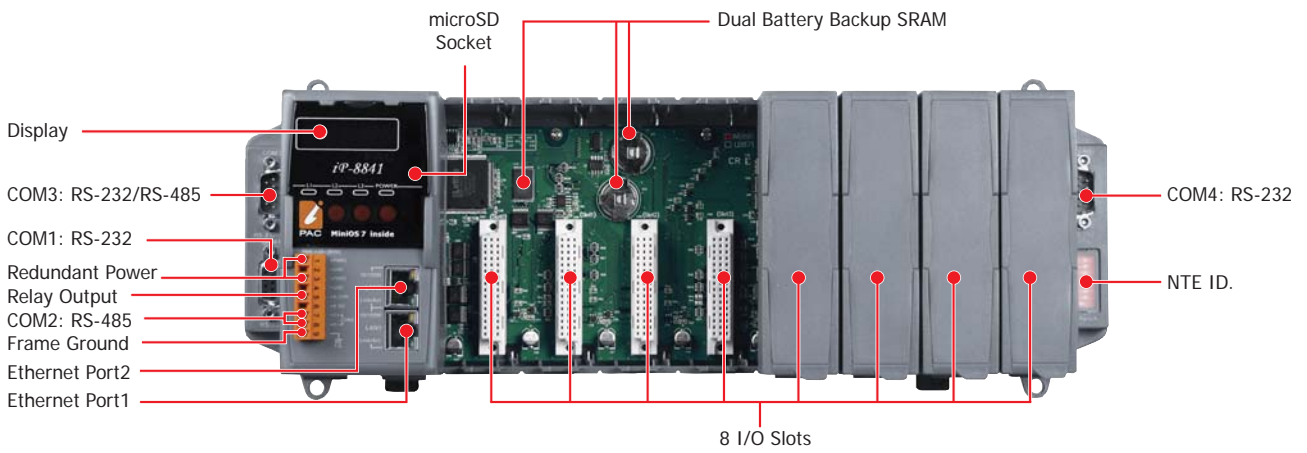

## Pin Assignments

**Terminal Block**

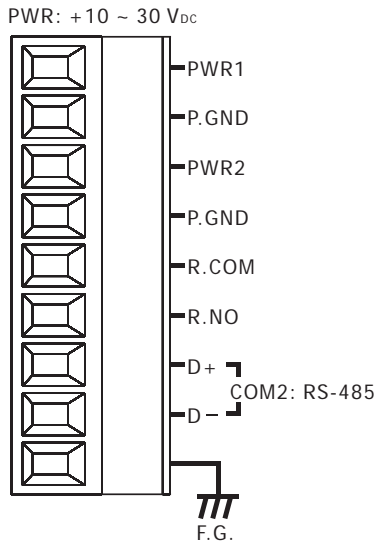

**COM Port**

COM1: RS-232

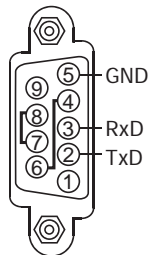

COM3: RS-232/RS-485

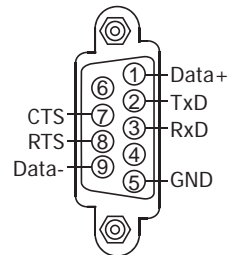

COM4: RS-232

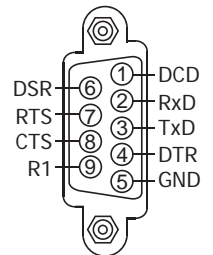

## ■ Dimensions (Unit: mm)

**iP-8411/8441/8441-FD**

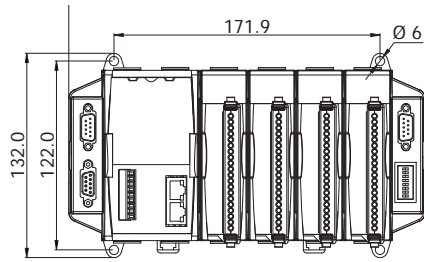

Front View

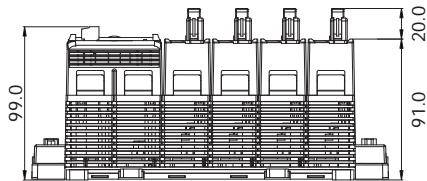

Bottom View

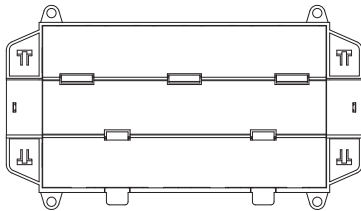

Rear View

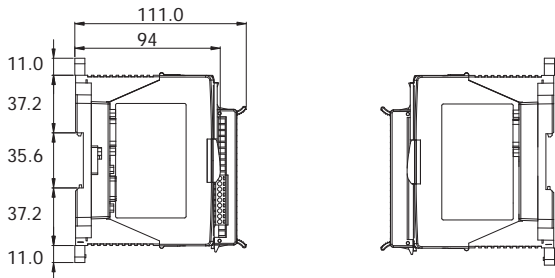

Left View

Right View

**iP-8811/8841/8841-FD**

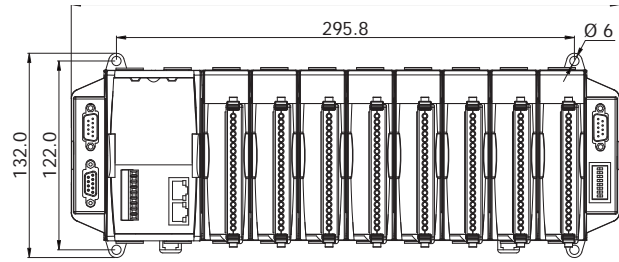

Front View

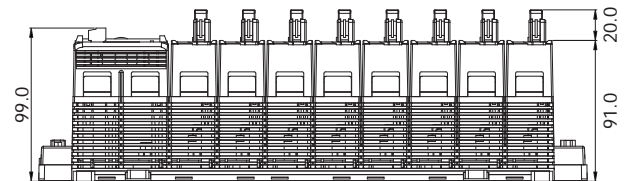

Bottom View

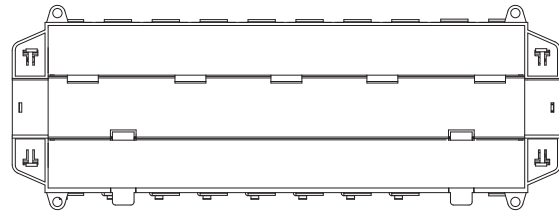

Rear View

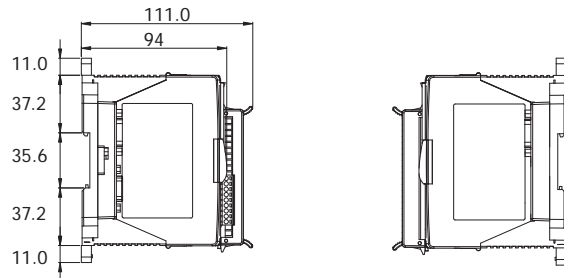

Left View

Right View

## ■ Ordering Information

<b>iP-8411 CR</b>	Standard iPAC-8000 without Ethernet ports (RoHS)
<b>iP-8811 CR</b>	Standard iPAC-8000 without Ethernet ports (RoHS)
<b>iP-8441 CR</b>	Standard iPAC-8000 with 4 I/O Slots (RoHS)
<b>iP-8841 CR</b>	Standard iPAC-8000 with 8 I/O Slots (RoHS)
<b>iP-8441-FD CR</b>	Standard iPAC-8000 with 256 MB Flash (RoHS)
<b>iP-8841-FD CR</b>	Standard iPAC-8000 with 256 MB Flash (RoHS)