

1. How to download files to i-7188/i-8000 series modules?

Original Writer: Sean Hsu
Last Editor: Vic Tsai, 8/30/2007

I. Use the MiniOS7 Utility

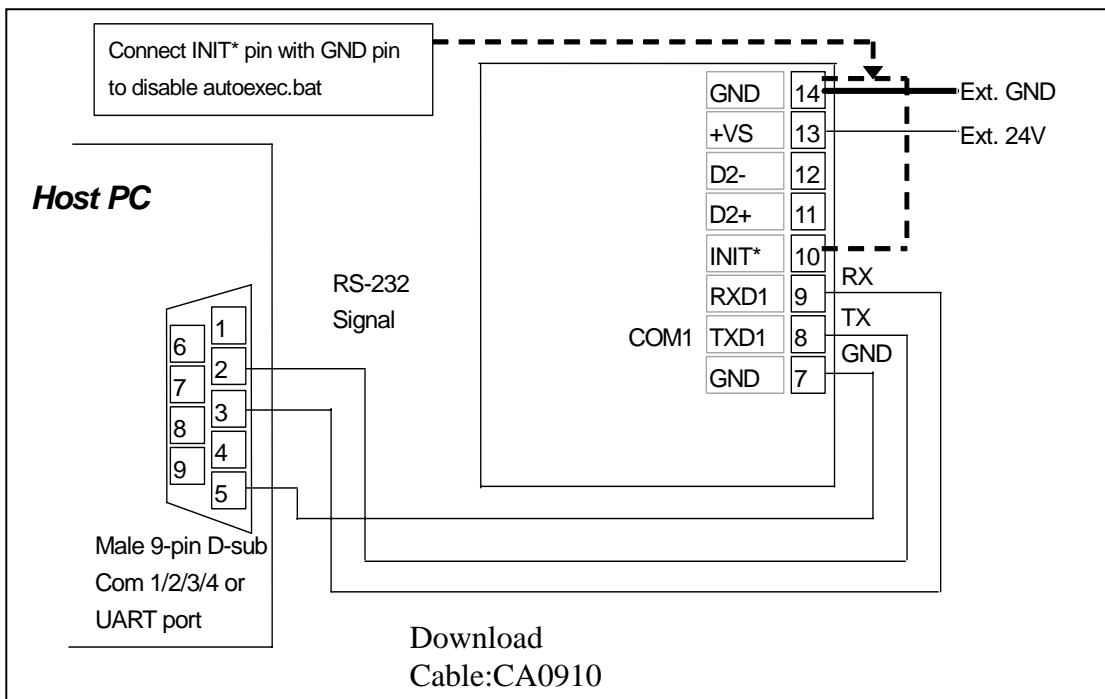
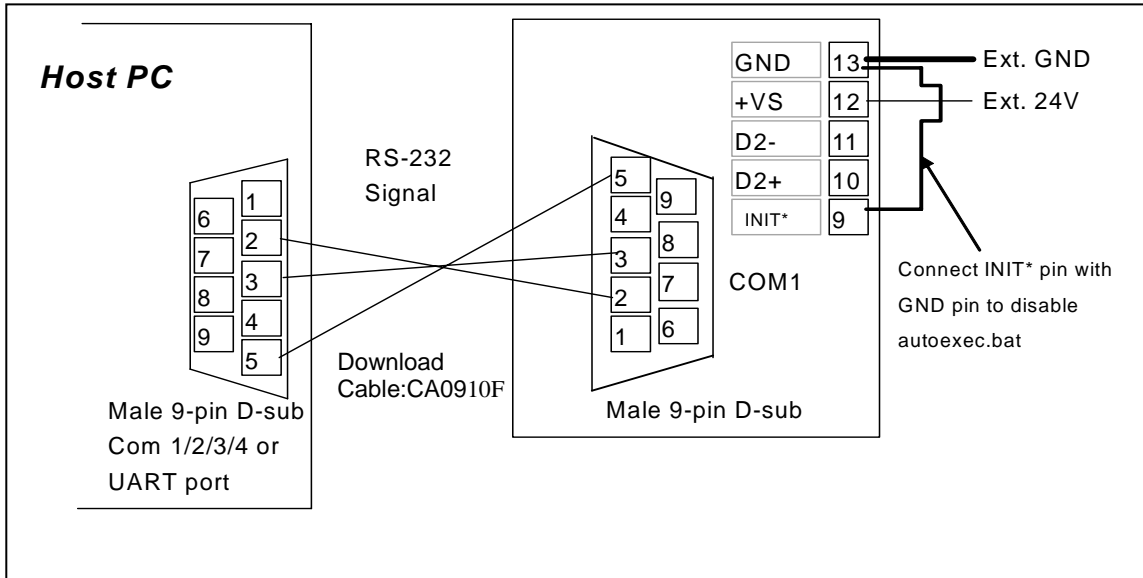

Step 1: Connect the module and Host PC with download-cable, CA0910/CA0910F. As shown in the above diagram.

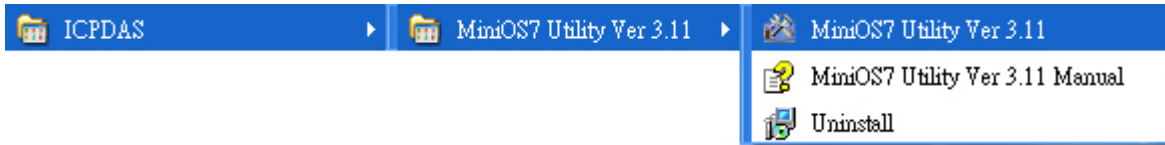

Note: The download port is COM4 for i-7188/i-7188XA, not COM1. The diagram may be different from your module. Don't be worried. Two main things: (1) Connect Host PC and download port (COM1/COM4) with download cable. (2) Connect INIT* pin with GND pin.

Step 2: Installs MiniOS7 Utility. From the Windows START menu, go to Programs/ICPDAS/MiniOS7 Utility Ver 3.11/and locate the **MiniOS7 Utility Ver3.11**.

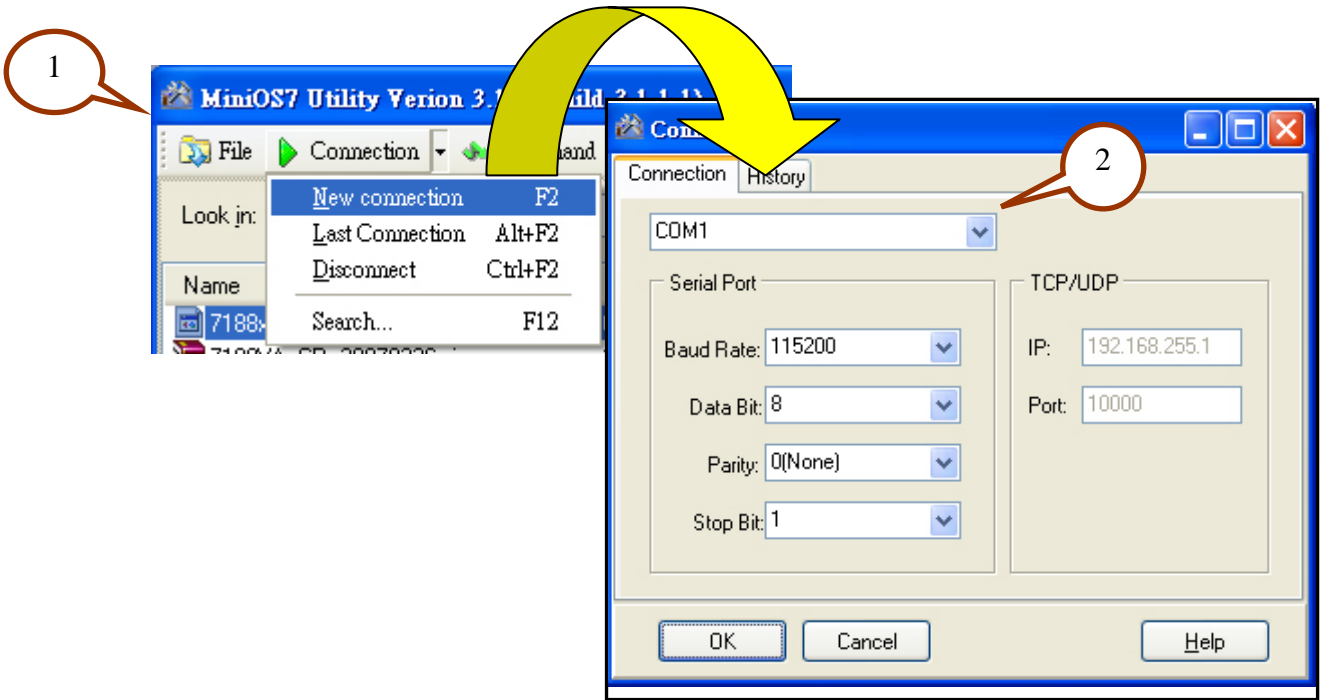

Step 3: Press  **Connection** and Select "New connection". Choose the right COM port and set other parameters. Click **OK** button and the utility will search module automatically.



Step 4: See if the MiniOS7 Utility connects with i-7188/i-8000 series modules. The connected icon is  The disconnected icon is 

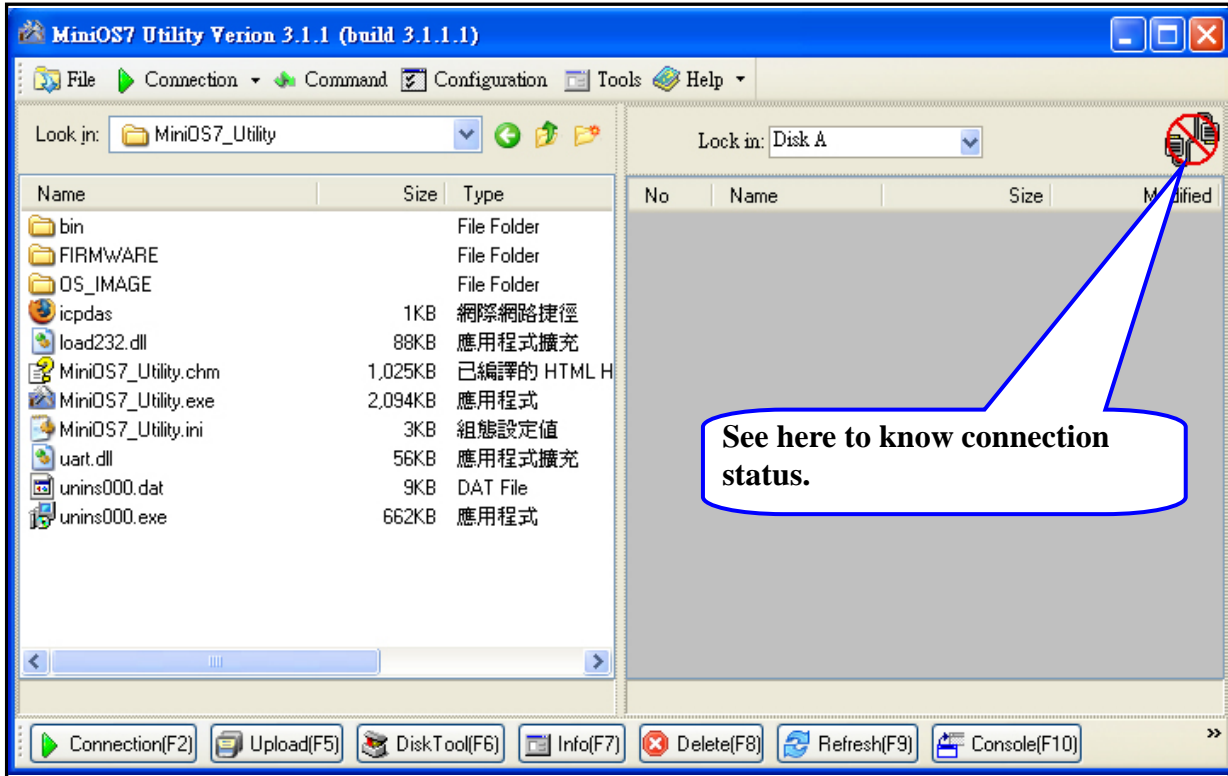

Step 5: Select the file to load from left side and click  to load file into module or draw the file to the right side.

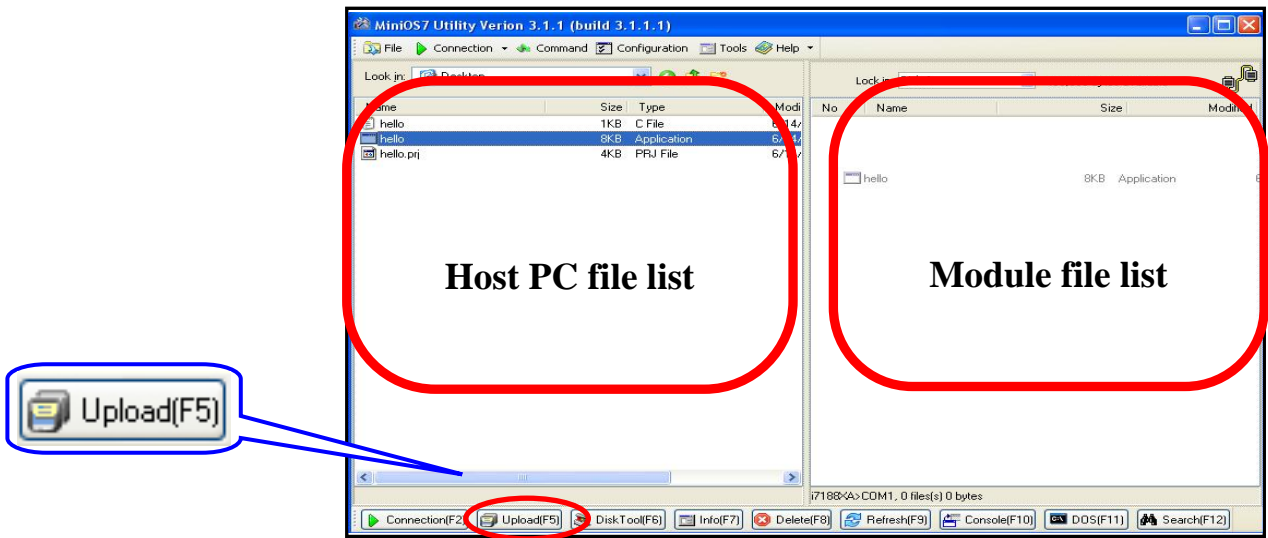

Step 6: Select the file and then press the right mouse button. Choose the **Run** and press to execute the program.

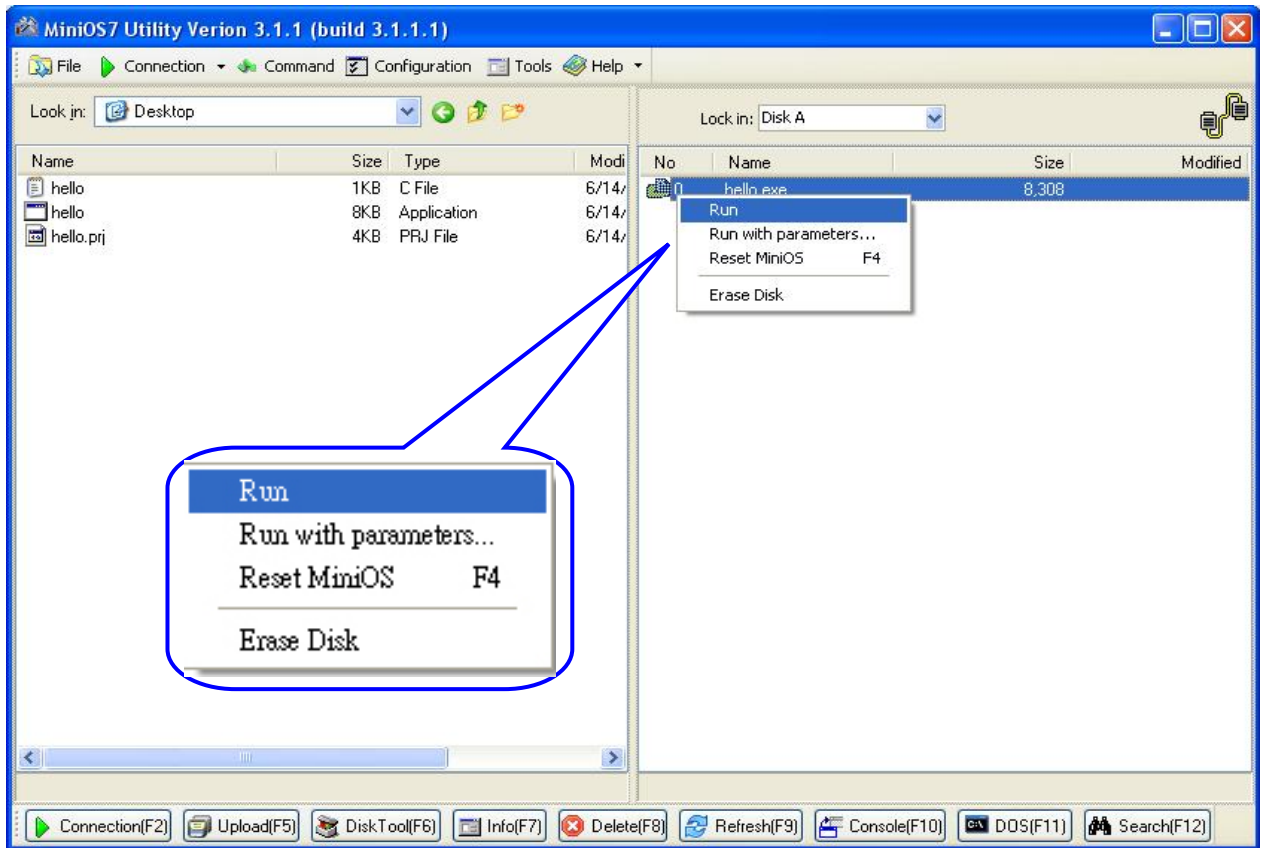

Step 7: The result of the program will be shown in 7188xw window.

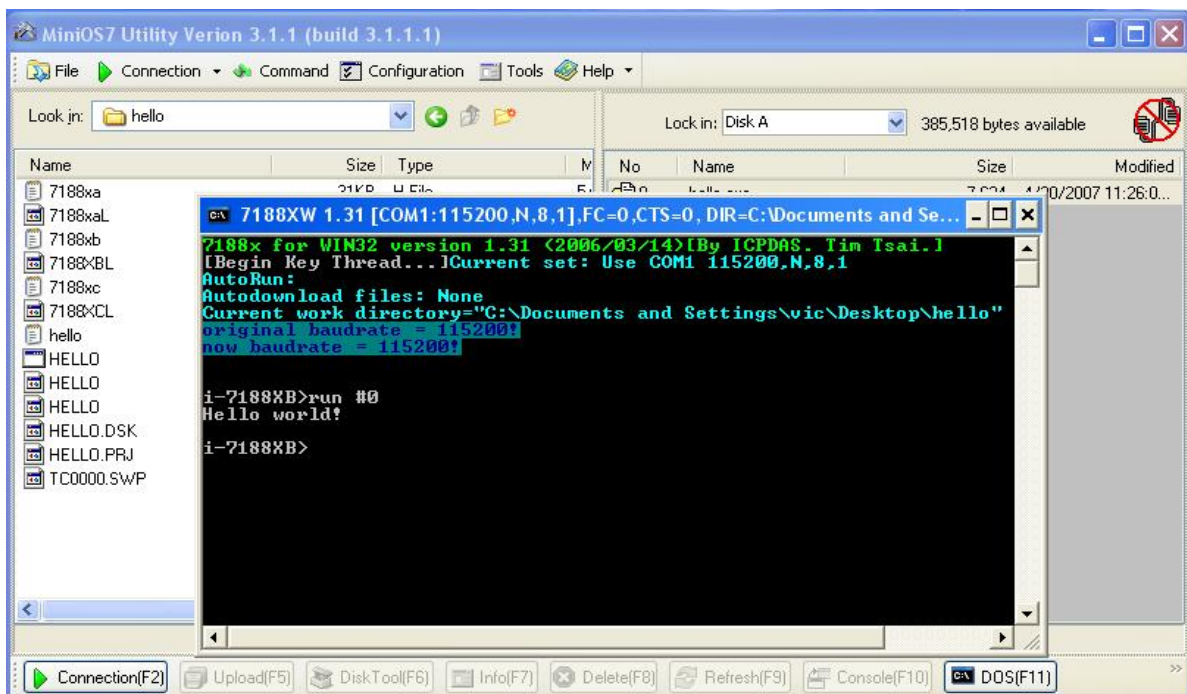

NOTE: The 7188xw window has to be closed and then the download operation (Step 5) could be done.

II. Use the 7188xw Utility

(The example is i-7188XB)

Step 1: Refer to Step1 in Sec. I. Use the MiniOS7 Utility.

Step 2: Connect INT* pin to GND pin to disable autoexec.bat before turning on the power.

Step 3: Build a folder which includes files which will be downloaded.

Two ways to use 7188xw.exe:

- Put files and 7188xw.exe in the same folder on the Host PC. Execute 7188xw.exe and jump to Step 8.
- Jump to Step 4

Step 4: Copy the 7188xw.exe file to the PATH directory, for example C:\DOS or C:\WINDOWS and then it will be able to be executed to download files from any location

Step 5: Run a MS-DOS box in windows is as follows:

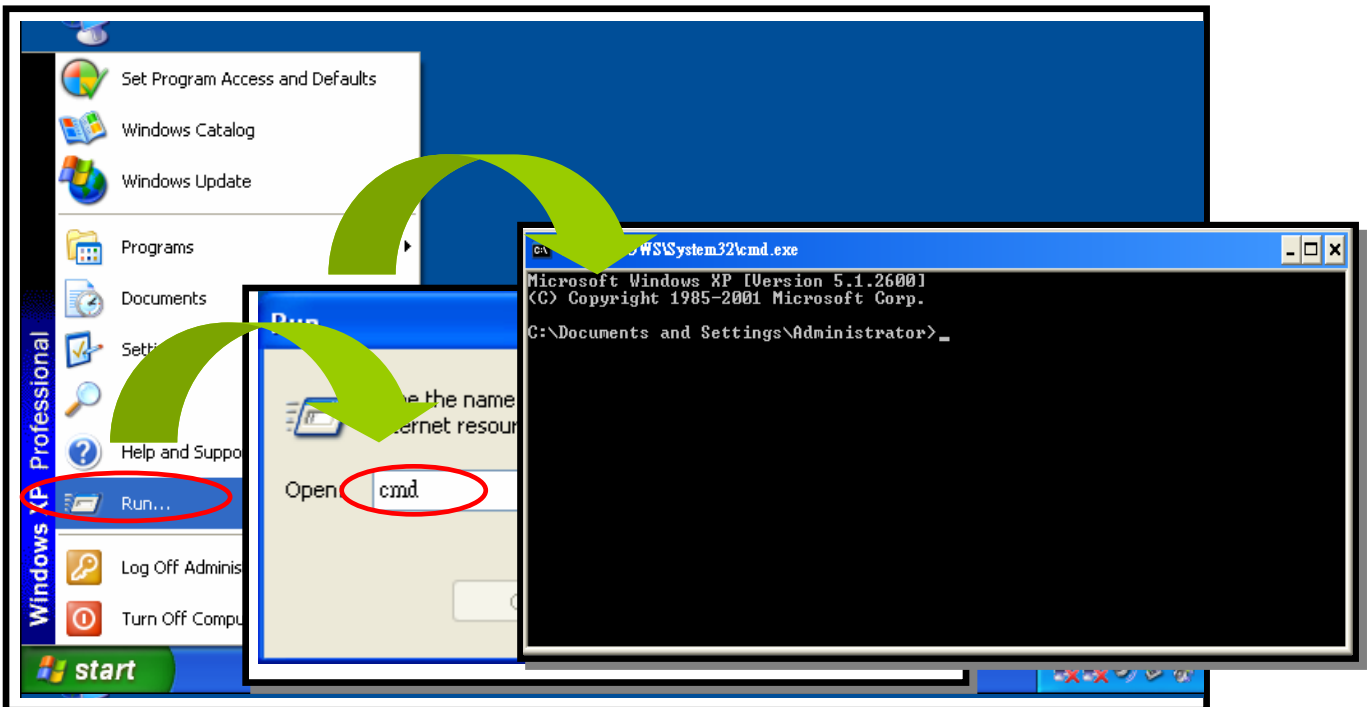

Step 6: Type "cd c:\7188XB\Demo\BC_TC\Hello\Hello_C\" then press <Enter>. (Assume user build a folder to C drive letter.)

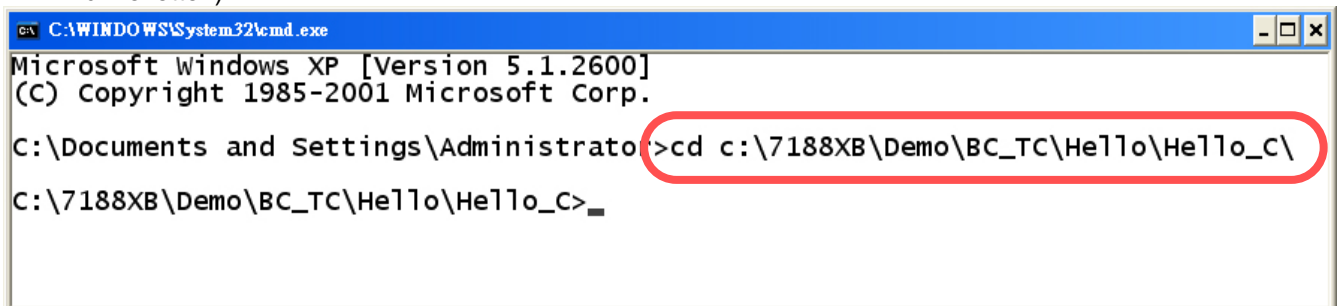

Step 7: Execute the 7188xw.exe application as shown in the following figure.

```
C:\ 7188XW 1.32 [COM1:115200,N,8,1],FC=0,CTS=0, DIR=C:\7188XB\Demo\BC_TC\Hello\Hello_C
C:\7188XB\Demo\BC_TC\Hello\Hello_C(>7188xw

7188x for WIN32 version 1.32 (2006/10/17)[By ICPDAS. Tim Tsai.]
[Begin Key Thread...]
Current set: Use COM1 115200,N,8,1
AutoRun:
Autodownload files: None
Current work directory="C:\7188XB\Demo\BC_TC\Hello\Hello_C"
original baudrate = 115200!
now baudrate = 115200!
```

Note: Select the active COM port of the Host PC and execute 7188xw.exe.
If the module is connected to COM1 on PC, then type **7188xw /c1**
If the module is connected to COM2 on PC, then type **7188xw /c2**

Step 8: Press <F2> and then type the filename "Hello.exe" and press <Enter>.

```
C:\ 7188XW 1.32 [COM1:115200,N,8,1],FC=0,CTS=0, DIR=C:\7188XB\Demo\BC_TC\Hello\Hello_C
C:\7188XB\Demo\BC_TC\Hello\Hello_C>7188xw

7188x for WIN32 version 1.32 (2006/10/17)[By ICPDAS. Tim Tsai.]
[Begin Key Thread...]
Current set: Use COM1 115200,N,8,1
AutoRun:
Autodownload files: None
Current work directory="C:\7188XB\Demo\BC_TC\Hello\Hello_C"
original baudrate = 115200!
now baudrate = 115200!

i-7188XB>
Input filename:Hello.exe
When Press F8/F9/F10 will auto download the file:Hello.exe
```

Step 9: Press <F8> to download the Hello.exe file to the I-7188XB(D) and execute the program.

```
C:\ 7188XB W 1.32 [COM1:115200,N,8,1],FC=0,CTS=0, DIR=C:\7188XB\Demo\BC_TC\Hello\Hello_C
i-7188XB>
Input filename:Hello.exe
When Press F8/F9/F10 will auto download the file:Hello.exe
[F8]LOAD
File will save to 8000:0000
StartAddr-->7000:FFFF
Press ALT_E to download file!
Load file:Hello.exe[crc=4BBF,0000]
Send file info. total 28 blocks
Block 28
Transfer time is: 1.969000 seconds

i-7188XB>Hello.exe
Hello world!
i-7188XB>_
```

Notes: A description of the Hotkey functions is as follows:

F8: Download a file to FLASH Memory, and then execute the program

F9: Download a file to FLASH Memory.

F10: Download a file to SRAM, and then execute the program.

Step 10: Type "dir" and press <Enter> to check that the files are stored in the Flash Memory of the I-7188XB(D).

```
C:\ 7188XB W 1.32 [COM1:115200,N,8,1],FC=0,CTS=0, DIR=C:\7188XB\Demo\BC_TC\Hello\Hello_C
i-7188XB>dir

0)Hello.exe    02/15/2007 18:06:12    7081[01BA9]8002:0000-81BC:0009
Total File number is 1  Free space=451607 bytes
i-7188XB>_
```

Step 11: Type "del /y" and press <Enter> to delete all files stored in the Flash Memory of the I-7188XB(D).

```
C:\ 7188XB W 1.32 [COM1:115200,N,8,1],FC=0,CTS=0, DIR=C:\7188XB\Demo\BC_TC\Hello\Hello_C
i-7188XB>del /y
Total File number is 1, do you really want to delete(y/n)?

i-7188XB>dir

Total File number is 0  Free space=458720 bytes
i-7188XB>_
```

Note: The MiniOS7 only supports the **delete all** command. Individual files cannot be selected for deletion.

Step 12: Press <Alt + X> to quit the MiniOS7.

2. How to update MiniOS7 image file?

I. Use the MiniOS7 Utility

The MiniOS7 Utility provides an easy way to upgrade MiniOS7. The upgrade procedure is as follows:
Step 1: Get the latest version of MiniOS7 image file.

The format of the image file name is: **TTYMMDD.img**

TT: TYPE of product.

YY: The year this image released

MM: The month this image released

DD: The day this image released

Note: The MiniOS7 image file contained on the companion CD can be found in CD:\NAPDOS\MiniOS7\ directory. The latest version of MiniOS7 can be downloaded from the ICP DAS website:

http://ftp.icpdas.com/pub/cd/8000cd/napdos/minios7/minios7_2.0/

Step 2: Execute the MiniOS7 Utility. Refer to Step1 in **I.Use the MiniOS7 Utility** of Sec.1 to connect the module. Select the MiniOS7 image file that you want to upgrade on the left side. Click the right mouse button to choose the "Update MiniOS7 Image".

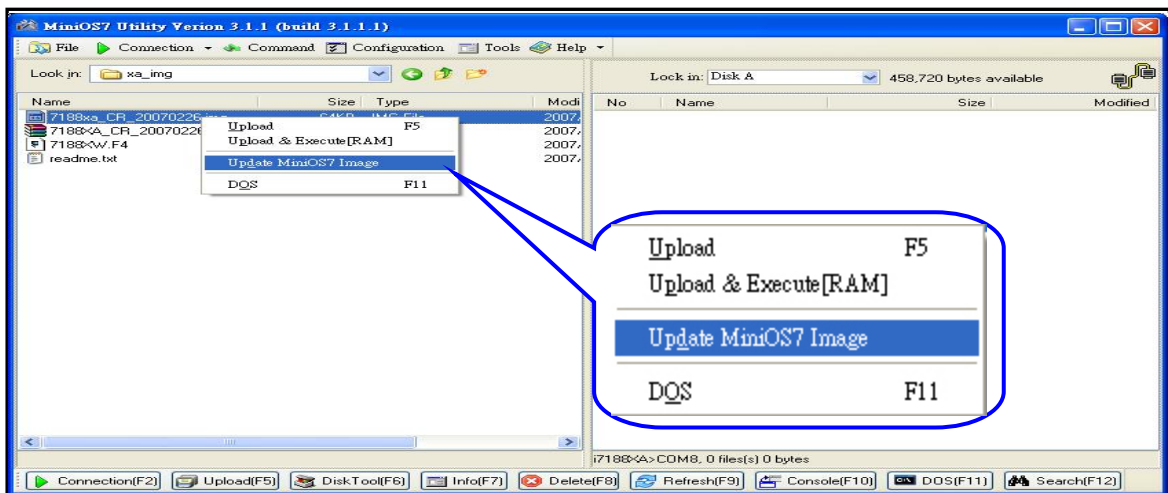

Step 3: It will take about 10 seconds for the upgrade to finish. If the MiniOS7 was updated successfully, a **Confirm** action dialog box will appear.

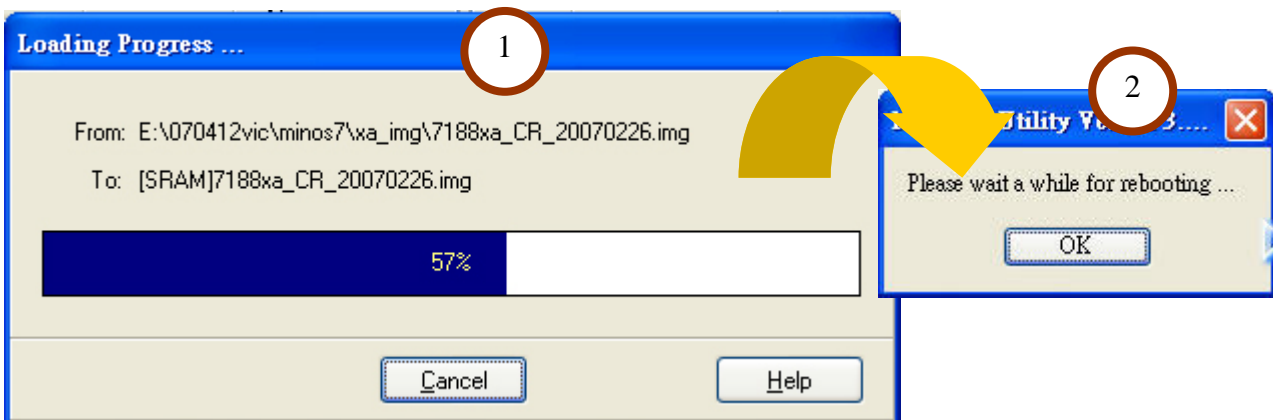

Step 4: Press  button and see the “Build” item to check the version number of the MiniOS7. The diagram is as follow:

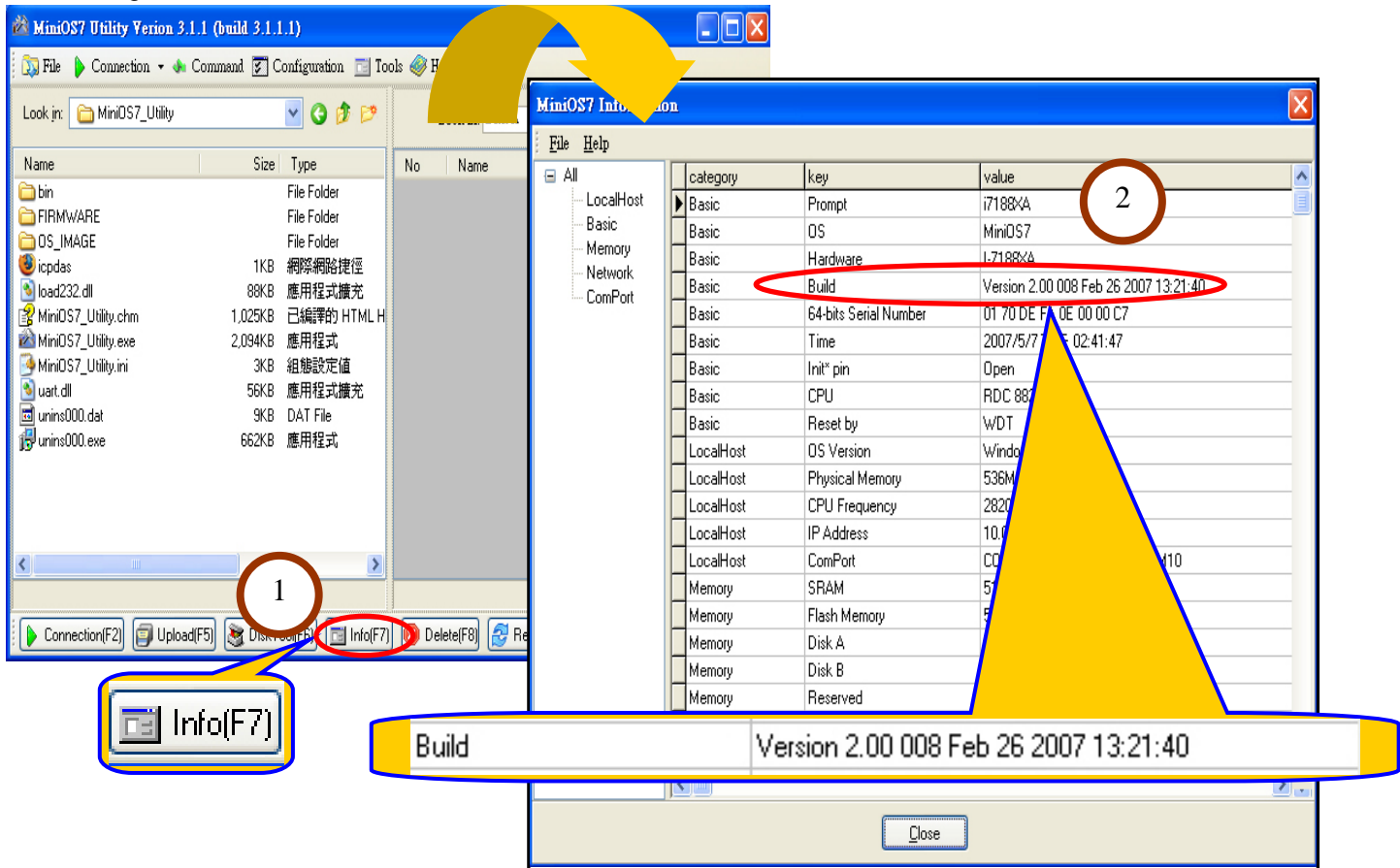

II. Use the 7188xw Utility

(The example is i-7188XA)

Step 1: Refer to Step1 in [I.Use the MiniOS7 Utility](#) of Sec.1 to connect the module.

Step 2: Determine the latest version of the MiniOS7 image file.
The format of the image file name is: **TTYMMDD.img**
TT: TYPE of product.
YY: Year that this image was released
MM: Month that this image was released
DD: Day that this image was released

Note: The MiniOS7 image file can be found in the CD:\NAPDOS\MiniO7\ directory on the companion CD. The latest MiniOS7 version can be downloaded from:

http://ftp.icpdas.com.tw/pub/cd/8000cd/napdos/minios7/minios7_2.0/

Step 3: From the Host PC, go to the directory where the image file is stored, then execute the 7188xw.exe application to connect the Host PC to the I-7188XA(D) controller.

Step 4: Use the "UPLOAD" command, then press <ALT + E> after the "Press ALT_E to download file!" message is shown on the screen.

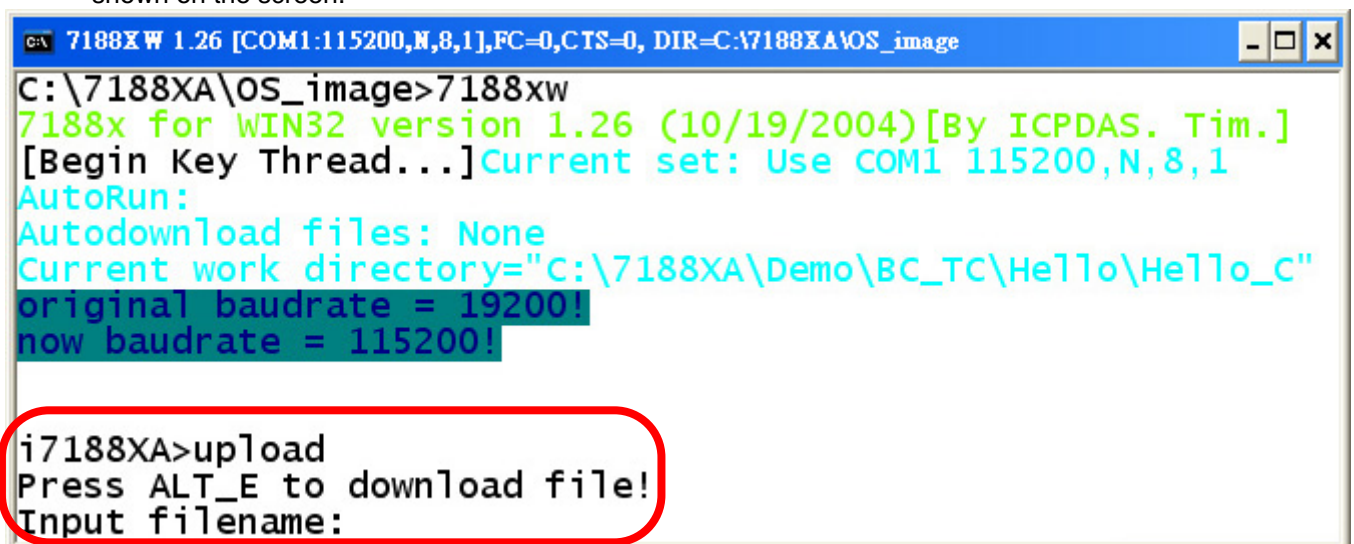

```
C:\7188XA\OS_image>7188xw
7188x for WIN32 version 1.26 (10/19/2004) [By ICPDAS. Tim.]
[Begin Key Thread...] Current set: Use COM1 115200,N,8,1
AutoRun:
Autodownload files: None
Current work directory="C:\7188XA\Demo\BC_TC\Hello\Hello_c"
original baudrate = 19200!
now baudrate = 115200!

i7188XA>upload
Press ALT_E to download file!
Input filename:
```

Step 5: Type the image filename (for example: xa050701.img) then press <ENTER>.

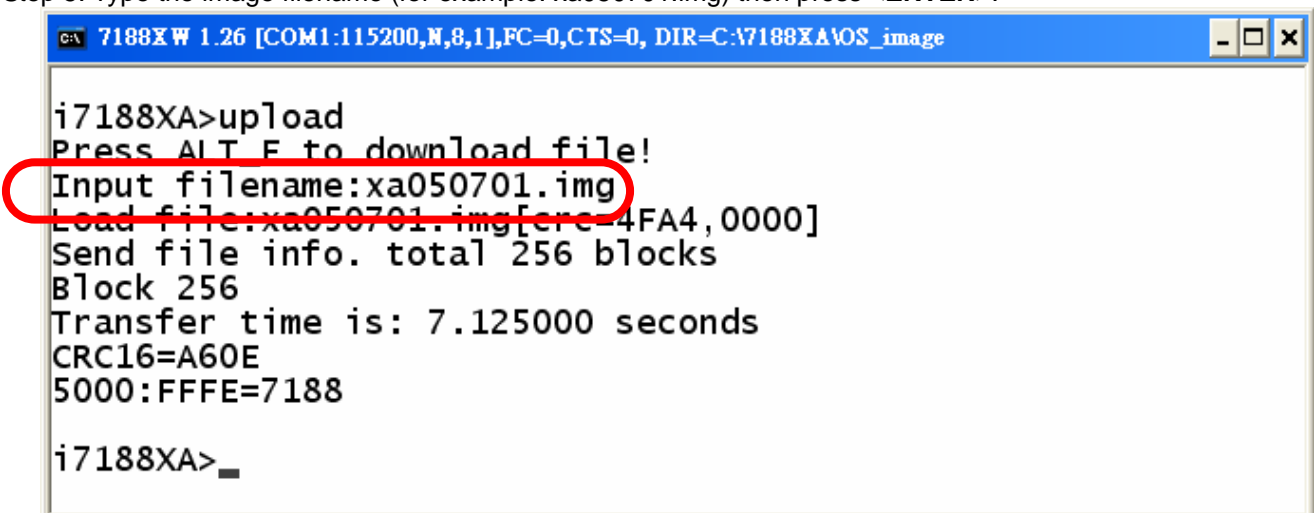

```
C:\7188XA\OS_image>7188xw

i7188XA>upload
Press ALT_E to download file!
Input filename:xa050701.img
Load file:xa050701.img[crc=4FA4,0000]
Send file info. total 256 blocks
Block 256
Transfer time is: 7.125000 seconds
CRC16=A60E
5000:FFFE=7188

i7188XA>_
```

Step 6: Wait for the upload to finish. (The image file will be stored in the SRAM.)

Step 7: Type the “**bios1**” command in the I-7188XA(D) command line. (The OS will check the image file stored in the SRAM, and then display the version information. If the image file is correct, it will be written to the Flash Memory.)



```
C:\7188XW 1.26 [COM1:115200,N,8,1],FC=0,CTS=0, DIR=C:\7188XA\OS_image
i7188XA>upload
Press ALT_E to download file!
Input filename:xa050701.img
Load file:xa050701.img[crc=4A59,0000]
Send file info. total 256 blocks
Block 256
Transfer time is: 7.125000 seconds
CRC16=A60E
5000:FFFE=7188
i7188XA>bios1_
```

Step 8: It will take about 10 seconds to upgrade MiniOS7. After the update has finished, the system will automatically reboot. If this does not occur, the system must be rebooted manually.



```
C:\7188XW 1.26 [COM1:115200,N,8,1],FC=0,CTS=0, DIR=C:\7188XA\OS_image
i7188XA>bios1
MiniOs7 for 7188XA Ver 2.00.003, date=07/01/2005
Checking CRC-16...OK.
Update the OS code. Please wait the message <<Write Finished>>
Erase Flash [F000]
Write Flash
[FF]
<<Write Finished>>OK
Wait WDT reset system...
i7188XA>_
```

Step 9: Type the “**ver**” command to check the MiniOS7 version number.

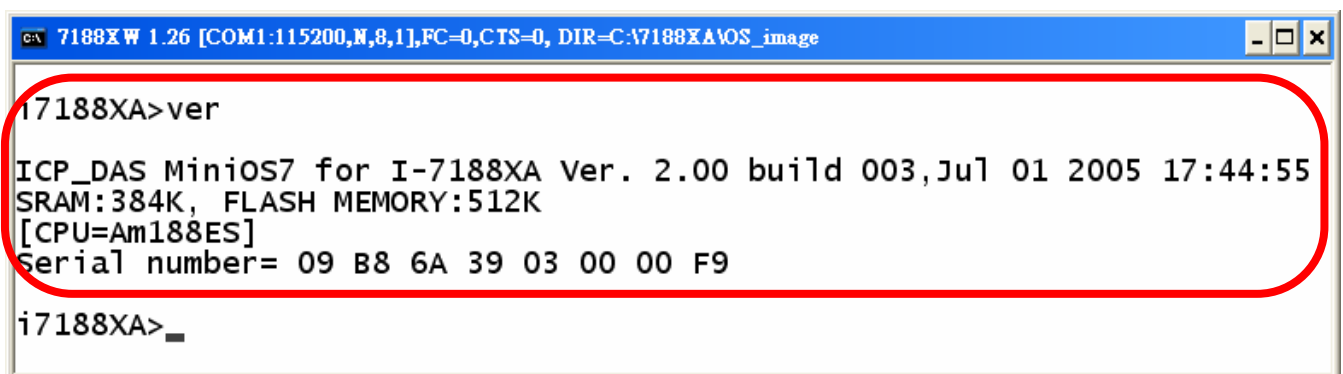

```
C:\7188XW 1.26 [COM1:115200,N,8,1],FC=0,CTS=0, DIR=C:\7188XA\OS_image
i7188XA>ver
ICP_DAS MiniOS7 for I-7188XA Ver. 2.00 build 003,Jul 01 2005 17:44:55
SRAM:384K, FLASH MEMORY:512K
[CPU=Am188ES]
Serial number= 09 B8 6A 39 03 00 00 F9
i7188XA>_
```

3. Download the Utilities?

MiniOS7 Utility:

CD: Napdos\MiniOS7\utility\MiniOS7_utility

<http://www.icpdas.com/download/minios7.htm>

7188xw:

CD: Napdos\MiniOS7\utility\ (Included 7188xw document.) or

<http://ftp.icpdas.com/pub/cd/8000cd/napdos/minios7/utility/> (Included 7188xw document.)