

NS-209F Series/NSM-209F Series

Unmanaged 8-port Industrial 10/100 Base-TX with 100 Base-FX Fiber Switch

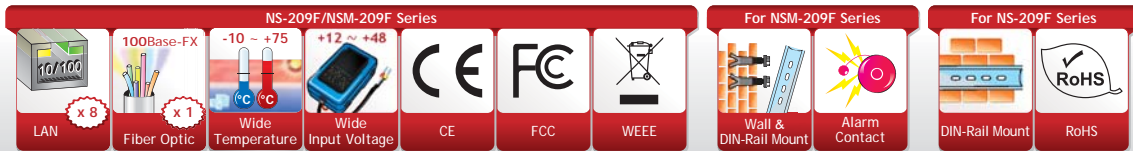

Features ▶▶▶

- Each port supports both 10/100 Mbps speed auto negotiation
- Automatic MDI/MDI-X crossover for plug-and-play
- Full duplex IEEE 802.3x and half duplex backpressure flow control
- DIN-Rail Mounting or Wall Mounting for NSM-209F series
- MAC address 2048
- Store-and-forward architecture
- Supports +12 V_{DC} ~ +48 V_{DC} power input
- DIN-Rail Mounting for NS-209F series

Introduction

The NS-209F/NSM-209F series is a Unmanaged 8-port Industrial 10/100 Base-TX with 100 Base-FX Switch that secures data transmission by using fiber optic transmission to provide immunity from EMI/RFI interference. It uses Ethernet for transmitting a signal up to 30 km, and is the perfect solution for applications where transmission must be protected from electrical exposure, surges, lightning or chemical corrosion.

The NS-209F/NSM-209F series operates at full duplex mode. In full duplex mode, range is 30 km with 8.3/125, 8.7/125, 9/125 or 10/125 μm fiber cables.

NSM-209F provides two power inputs that can be connected simultaneously to live DC power sources. If one of the power inputs fails, the other live source will act as a backup to automatically support the NSM-209F's power needs.

Specifications

Models	NS-209F Series	NSM-209F Series
Technology		
Standards	IEEE 802.3, 802.3u, 802.3x	
Processing Type	Store & forward; wire speed switching	
MAC Addresses	2048	
Memory Bandwidth	2 Gbps	
Frame Buffer Memory	512 Kbit	
Flow Control	IEEE 802.3x flow control, back pressure flow control	
Ethernet Interface		
RJ-45 Ports	10/100 Base-T(X) auto negotiation speed, F/H duplex mode, and auto MDI/MDI-X connection	
LED Indicators	Power, Link/Act, 10/100M	
Fiber Optics Port	100 Base-FX	
Ethernet Isolation	1500 V _{rms} 1 minute	
EMS Protection	Yes	

Models		NS-209F Series	NSM-209F Series
Fiber Interface (100 Base-FX; SC/ST type)			
Multi-Mode	NS-209FT/FC NSM-209FT/FC	Multi mode fiber cables: 50/125, 62.5/125 or 100/140 μ m Distance: 2 km, (62.5/125 μ m recommended) for full duplex Wavelength: 1300 or 1310 nm Min. TX Output: -20 dBm Max. TX Output: -14 dBm Max. RX Sensitivity: -32 dBm	
Fiber Interface (100 Base-FX; SC/ST type)			
Single-Mode	NS-209FCS NSM-209FCS	Single-mode fiber cables: 8.3/125, 8.7/125, 9/125 or 10/125 μ m Distance: 30 km, (9/125 μ m recommended) for full duplex Wavelength: 1300 or 1310 nm Min. TX Output: -15 dBm Max. TX Output: -8 dBm Min. RX Sensitivity: -34 dBm	
Power Input			
Input Voltage Range	+12 Vdc ~ +48 Vdc (Non-isolated)	+12 Vdc ~ +48 Vdc (Non-isolated) Redundant Inputs with one relay output (1 A @ 24 Vdc) for alarm	
Power Consumption	0.26 A @ 24 Vdc		
LED Indicator	Yes		
Protection	Power reverse polarity protection		
+/-4 kV ESD Protection	Yes		
Mechanical			
Casing	Plastic (Flammability UL 94V-0)	Metal (IP20 Protection)	
Dimensions (W x L x H)	64 mm x 101 mm x 118 mm	73 mm x 105 mm x 132 mm	
Installation	DIN-Rail Mounting	DIN-Rail Mounting or Wall Mounting	
Environmental			
Operating Temperature	-10 °C ~ +75 °C		
Storage Temperature	-20 °C ~ +85 °C		
Ambient Relative Humidity	10% ~ 90% RH, non-condensing		

Redundant Power Input

Both power inputs can be connected simultaneously to live DC power sources.

If one power source fails, the other live source will act as a backup, and automatically supplies all of NSM-209F series power needs.

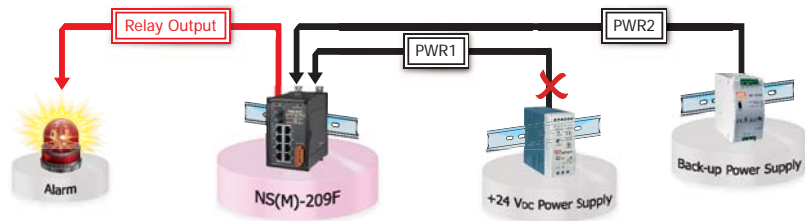

Dimensions (Units: mm)

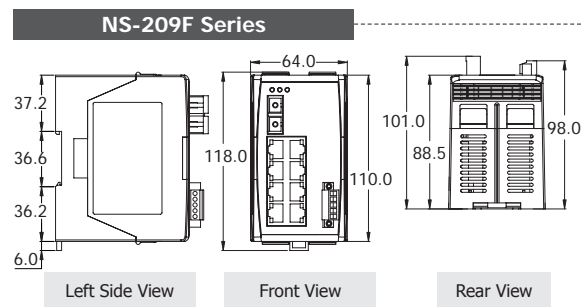
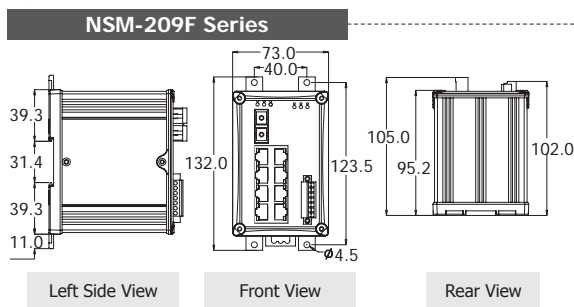

Ordering Information

NS-209FT CR	Multi-mode, ST Connector, 8-port 10/100 Mbps with 1 Fiber port Switch (RoHS)
NS-209FC CR	Multi-mode, SC Connector, 8-port 10/100 Mbps with 1 Fiber port Switch (RoHS)
NS-209FCS CR	Single-mode 30 km, SC Connector, 8-port 10/100 Mbps with 1 Fiber port Switch (RoHS)
NSM-209FT	Multi-mode, ST Connector, 8-port 10/100 Mbps with 1 Fiber port Switch; metal case
NSM-209FC	Multi-mode, SC Connector, 8-port 10/100 Mbps with 1 Fiber port Switch; metal case
NSM-209FCS	Single-mode 30 km, SC Connector, 8-port 10/100 Mbps with 1 Fiber port Switch; metal case

Accessories

DIN-KA52F	24V/1.04A, 25 W Power Supply with DIN-Rail Mounting
MDR-20-24	24V/1A, 24 W Power Supply with DIN-Rail Mounting
MDR-60-24	24V/2.5A, 60 W Power Supply with DIN-Rail Mounting